

TENTATIVE SUBDIVISION MAP
WHITNEY RANCH UNIT 49

ROCKLIN, CA

JUNE 2022

OWNER/DEVELOPER

SOUTHERN PLACER TRANSPORTATION AUTHORITY
2615 SIERRA MEADOWS DRIVE
ROCKLIN, CA 95677
TEL (916) 624-7246

APPLICANT/ENGINEER

UBORA ENGINEERING AND PLANNING, INC.
2901 DOUGLAS BOULEVARD, SUITE 285
ROSEVILLE, CA 95661
TEL: (916) 780-2500
FAX: (916) 780-6777
DAVID BERRY, P.E. LIC NO. C48811

PROJECT INFORMATION

ASSESSOR PARCEL NUMBERS: 017-174-020
EXISTING GENERAL PLAN: PQP (PUBLIC/QUASI PUBLIC)
PROPOSED GENERAL PLAN: LDR (LOW DENSITY RESIDENTIAL)
EXISTING ZONING: SCHOOL/PD-5
PROPOSED ZONING: PD-5

LOTGING SUMMARY

	No. LOTS	ACRES	% COVERAGE
RESIDENTIAL LOTS	60	14.9	75%
LANDSCAPE PARCELS	A-C	1.54	8%
PUBLIC RIGHT-OF-WAY		3.46	17%
TOTAL		19.9	100%

LOT INFORMATION

MINIMUM LOT SIZE	7,592 SF
AVERAGE LOT SIZE	10,750 SF
MAXIMUM LOT SIZE	18,471 SF
MINIMUM LOT WIDTHS	70'
MINIMUM LOT DEPTH	100'

SHEET INDEX

SHEET 1	TITLE SHEET
SHEET 2	SITE PLAN
SHEET 3	LOTGING PLAN
SHEET 4	WATER AND SEWER PLAN
SHEET 5	GRADING AND DRAINAGE PLAN
SHEET 6	PRELIMINARY PLANTING PLAN
SHEET 7	PRELIMINARY PLANTING PLAN
SHEET 8	PRELIMINARY PLANTING DETAILS

Sheet 1 of 8
TITLE SHEET

UBORA ENGINEERING & PLANNING
"EXCELLENCE"

2901 DOUGLAS BOULEVARD, SUITE 285
ROSEVILLE, CA 95661 (916) 780-2500

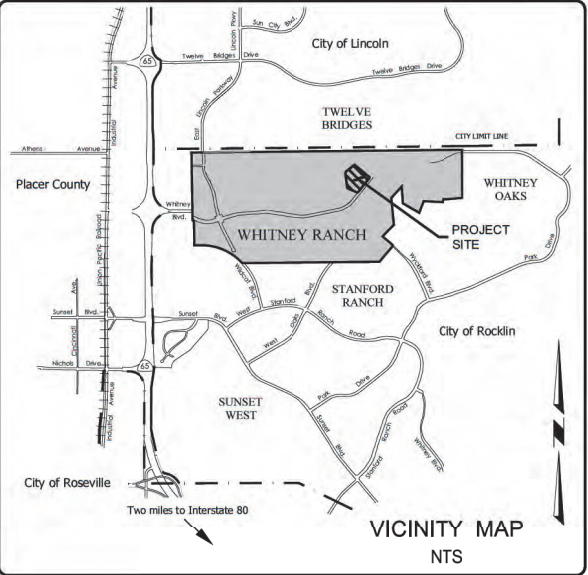
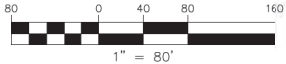

LEGEND:

- PROJECT BOUNDARY
- PROPOSED LOT LINE
- PROPOSED 12.5' P.U.E. (FRONT) 10' P.U.E. (SIDE)
- PROPOSED RIGHT-OF-WAY
- LOT NUMBER

GENERAL NOTES

1. **SEPTIC SYSTEM**
THERE ARE NO KNOWN EXISTING WELLS, ABANDONED WELLS, SUMPS, OR ANY OTHER UNDERGROUND SYSTEMS ON THE PROPERTY.
2. **TENTATIVE MAP**
DIMENSIONS AND AREAS SHOWN ARE APPROXIMATE AND SUBJECT TO CHANGE.

UTILITY PROVIDERS

WATER	PLACER COUNTY WATER AGENCY
SEWER	SOUTH PLACER MUNICIPAL UTILITY DISTRICT
GAS & ELECTRIC	PACIFIC GAS & ELECTRIC
TELEPHONE	CONSOLIDATED COMMUNICATIONS
CABLE TV	WAVE BROADBAND

SERVICE PROVIDERS

SCHOOL DISTRICT	ROCKLIN UNIFIED SCHOOL DISTRICT
FIRE PROTECTION	CITY OF ROCKLIN
POLICE PROTECTION	CITY OF ROCKLIN
STORM DRAINAGE	CITY OF ROCKLIN
SOLID WASTE	RECOLOGY AUBURN-PLACER









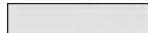

TENTATIVE SUBDIVISION MAP WHITNEY RANCH UNIT 49

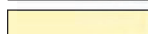
ROCKLIN, CA

JUNE 2022

LEGEND:

- 60 LOT NUMBER
-  PROPOSED STREET
-  PROPOSED SIDEWALK
-  PROPOSED LOT
-  LANDSCAPED AREAS
-  FUTURE PRIVACY FENCE PER DETAIL D ON SHEET 8
-  PILASTER PER DETAIL A ON SHEET 8
-  PROTO II WITH STONE VENEER PER DETAIL B ON SHEET 8
-  PROTO II WALL SPLIT FACE PER DETAIL C ON SHEET 8
-  6" CONCRETE MOW STRIP PER DETAIL E ON SHEET 8



A.D.A. ACCESSIBLE
PEDESTRIAN ACCESS
TO PARK

PEDESTRIAN STAIRWAY
ACCESS TO PARK

PERNU
PARK

OLD BRANCH
HOUSE ROAD

FUTURE
PCWA TANK SITE

SONGBIRD WAY

UNIT 46

UNIT 50

UNIT 44B

Sheet 2 of 8
SITE PLAN/PRELIMINARY
FENCING PLAN

UBORA ENGINEERING & PLANNING
"EXCELLENCE"

2901 DOUGLAS BOULEVARD, SUITE 285
ROSEVILLE, CA 95661 (916) 780-2530

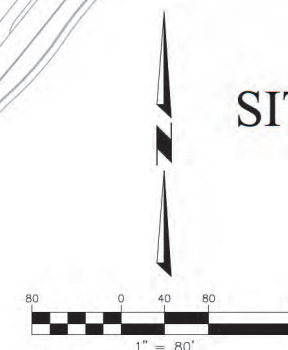





P:\Projects\110_10_WhitneyRanch\Submittal\110_10_CAD\Tentative_Map.dwg

TENTATIVE SUBDIVISION MAP WHITNEY RANCH UNIT 49

ROCKLIN, CA

JUNE 2022

LEGEND:

-  PROJECT BOUNDARY
-  PROPOSED LOT LINE
-  PROPOSED 12.5' P.U.E. (FRONT) 10' P.U.E. (SIDE)
-  PROPOSED RIGHT-OF-WAY
-  LOT NUMBER & AREA

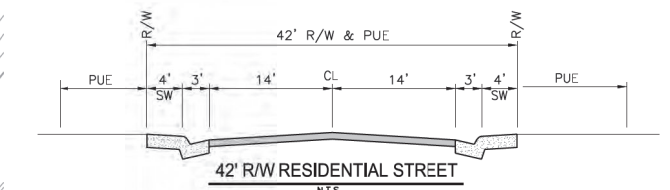
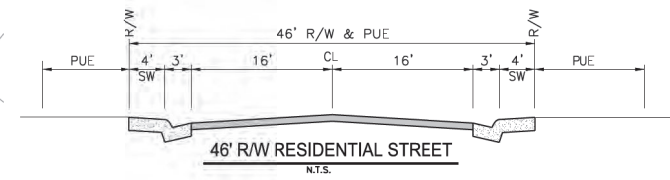

Sheet 3 of 8
LOTING PLAN

UBORA ENGINEERING & PLANNING
"EXCELLENCE"
2901 DOUGLAS BOULEVARD, SUITE 285
ROSEVILLE, CA 95661 (916) 780-2530

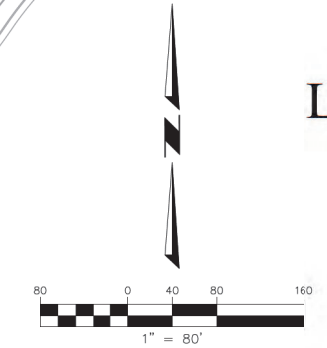











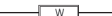

TENTATIVE SUBDIVISION MAP
WHITNEY RANCH UNIT 49

ROCKLIN, CA

JUNE 2022

LEGEND:

-  PROJECT BOUNDARY
-  PROPOSED LOT LINE
-  PROPOSED 12.5' P.U.E. (FRONT) 10' P.U.E. (SIDE)
-  PROPOSED RIGHT-OF-WAY
-  LOT NUMBER & ELEVATION
-  PROPOSED WATER LINE
-  PROPOSED FIRE HYDRANT ASSEMBLY
-  PROPOSED SANITARY SEWER LINE
-  PROPOSED SANITARY SEWER MANHOLE
-  EXISTING WATER LINE
-  EXISTING FIRE HYDRANT ASSEMBLY
-  EXISTING SANITARY SEWER LINE
-  EXISTING SANITARY SEWER MANHOLE



Sheet 4 of 8
WATER &
SEWER PLAN

UBORA ENGINEERING & PLANNING
"EXCELLENCE"

2901 DOUGLAS BOULEVARD, SUITE 285
ROSEVILLE, CA 95661 (916) 780-2500

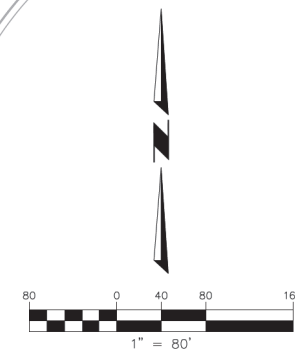

TENTATIVE SUBDIVISION MAP WHITNEY RANCH UNIT 49

ROCKLIN, CA

JUNE 2022

GRADING NOTES

- ALL INTERIOR LOTS SHALL BE GRADED AS CLASS 1 PER CITY OF ROCKLIN IMPROVEMENT STANDARDS SECTION 9-4-C-1.
- APPROXIMATE EARTHWORK: 40,000 CY CUT/FILL (BALANCE)

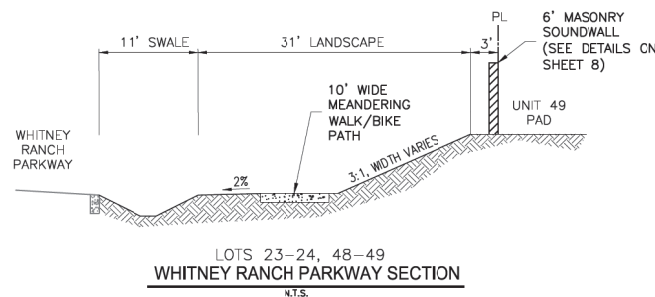
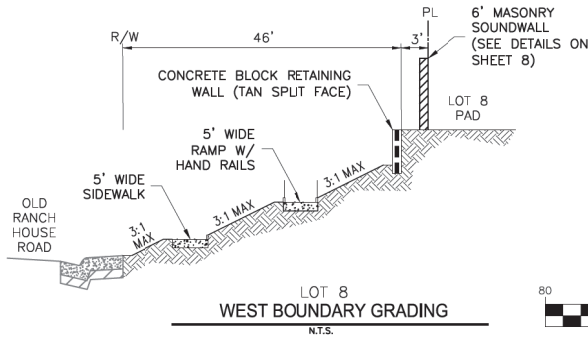
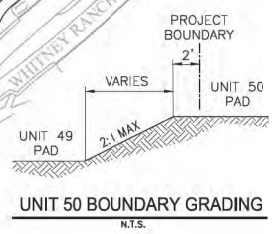
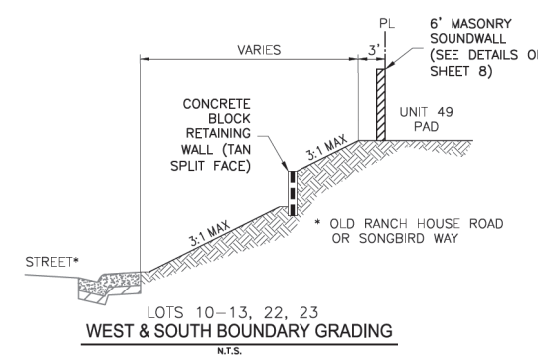
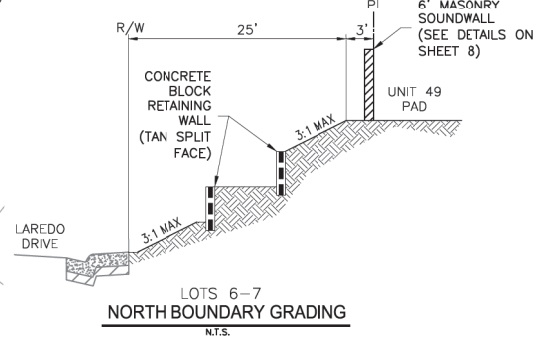
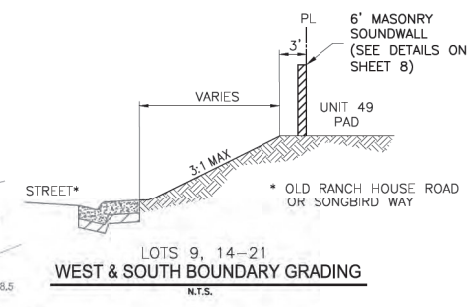
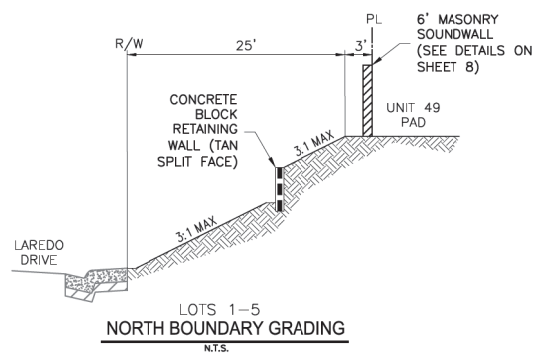
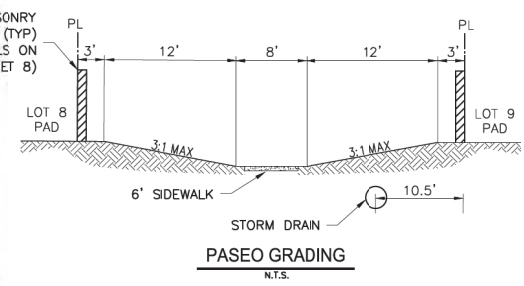

- ### LEGEND:
- PROJECT BOUNDARY
 - PROPOSED LOT LINE
 - PROPOSED 12.5' P.U.E. (FRONT) 10' P.U.E. (SIDE)
 - PROPOSED RIGHT-OF-WAY
 - L.P.: LOW POINT ELEVATION
 - H.P.: HIGH POINT ELEVATION
 - F.G.: FINISH GRADE ELEVATION
 - 360 --- EXISTING GROUND CONTOUR LINE
 - PROPOSED RETAINING WALL
 - TOP OF SLOPE
 - TOE OF SLOPE
 - 60 [341.0] LOT NUMBER & PAD ELEVATION
 - ±339.2 EXISTING SPOT ELEV. ALONG FRONTAGE
 - 367.9 EXISTING ADJACENT PAD ELEVATIONS
 - SD --- PROPOSED STORM DRAIN LINE
 - (D) PROPOSED STORM DRAIN MANHOLE
 - (T) PROPOSED WATER QUALITY TREATMENT STRUCTURE
 - PROPOSED "TYPE B" DRAIN INLET
 - SD --- EXISTING STORM DRAIN LINE

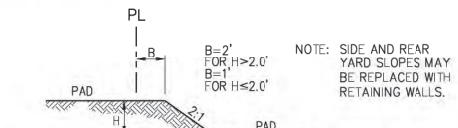

Sheet 5 of 8 GRADING & DRAINAGE PLAN

UBORA ENGINEERING & PLANNING
"EXCELLENCE"
2901 DOUGLAS BOULEVARD, SUITE 285
ROSEVILLE, CA 95661 (916) 780-2500

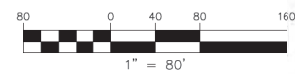

TENTATIVE SUBDIVISION MAP WHITNEY RANCH UNIT 49

ROCKLIN, CA

APRIL 2022



PLANT SCHEDULE

TREES	CODE	BOTANICAL / COMMON NAME	SIZE	WATER USE	QTY
	ACE JCS	ACER TRUNCATUM X PLATANOIDES 'FS-KW202' TM CRIMSON SUNSET MAPLE	24" BOX	M	47
	CER OCC	CERCIS OCCIDENTALIS WESTERN REDBUD	15 GAL.	L	15
	KOE PAN	KOELREUTERIA PANICULATA GOLDEN RAIN TREE	15 GAL.	M	20
	LAG IXF	LAGERSTROEMIA INDICA X FAURIEI 'TJSCARORA' TUSCARORA CRAPE MYRTLE	15 GAL.	L	10
	MAG ALE	MAGNOLIA X SOULANGEANA 'ALEXANDRINA' ALEXANDRINA SAUCER MAGNOLIA	15 GAL.	M	7
	TIL GSP	TILIA CORDATA 'GREENSPIRE' GREENSPIRE LITTLELEAF LINDEN	15 GAL.	M	28
	ULM DRA	ULMUS PARVIFOLIA 'DRAKE' DRAKE LACEBARK ELM	15 GAL.	M	16

CONCEPT PLANT SCHEDULE

	FOUNDATION/SCREENING SHRUBS ABELIA X GRANDIFLORA 'DWARF' / DWARF GLOSSY ABELIA CEANOTHUS X 'CONCHA' / CONCHA WILD LILAC RHAMNUS CALIFORNICA 'MOUND SAN BRUNO' / CALIFORNIA COFFEEBERRY	5 GAL., L 5 GAL., L 5 GAL., L
	FILLER ARCTOSTAPHYLOS DENSIFLORA 'HOWARD MCMINN' / HOWARD MCMINN MANZANITA CALLISTEMON VIMINALIS 'LITTLE JOHN' / DWARF WEEPING BOTTLEBRUSH DIETES BICOLOR / FORTNIGHT LILY GREVILLEA X 'NOELLII' / GREVILLEA RHAPHIOLEPIS UMBELLATA 'MINOR' / YEDDA HAWTHORN	5 GAL., L 5 GAL., L 5 GAL., L 5 GAL., L 5 GAL., L
	ACCENT SHRUBS/GRASSES ACACIA COGNATA 'ACCOG01' / COUSIN ITT LITTLE RIVER WATTLE CALAMAGRSTIS X ACUTIFLORA 'KARL FOERSTER' / FEATHER REED GRASS MUHLENBERGIA CAPILARIS / PINK MUHLY ROSA X 'RED' / RED CARPET ROSE SALVIA GREGGII 'HOT LIPS' / AUTUMN SAGE	5 GAL., L 1 GAL., L 1 GAL., L 2 GAL., M 1 GAL., L
	GROUNDCOVERS COTONEASTER DAMMERI 'LOWFAST' / LOWFAST BEARBERRY COTONEASTER HYPERICUM CALYCHINUM / CREEPING ST. JOHN'S WORT JUNIPERUS HORIZONTALIS 'BLUE CHIP' / BLUE CHIP JUNIPER MYOPORUM PARVIFOLIUM 'PUTAH CREEK' / PUTAH CREEK MYOPORUM TEUCRIUM CHAMAEDRYS 'PROSTRATUM' / PROSTRATE GERMANDER	1 GAL., L 1 GAL., L 1 GAL., L, LOW 1 GAL., L, LOW 1 GAL., L
	BIO BIOFILTRATION SOD AVAILABLE FROM DELTA BLUEGRASS COMPANY 80C.637.8873	SOD, M

Sheet 6 of 8 PRELIMINARY PLANTING PLAN

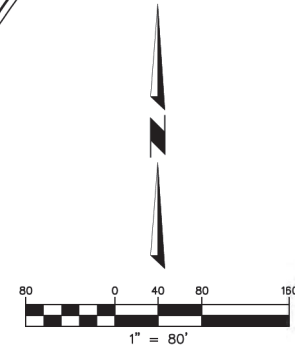

**FUHRMAN LEAMY
LAND GROUP**
DESIGN • SERVICE • SOLUTIONS
2140 PROFESSIONAL DRIVE, SUITE 115 ROSEVILLE, CA 95661
(916) 783-5263 info@fllandgroup.com

UBORA ENGINEERING & PLANNING
"EXCELLENCE"
2901 DOUGLAS BOULEVARD, SUITE 285
ROSEVILLE, CA 95661 (916) 780-2530

TENTATIVE SUBDIVISION MAP WHITNEY RANCH UNIT 49

ROCKLIN, CA

APRIL 2022

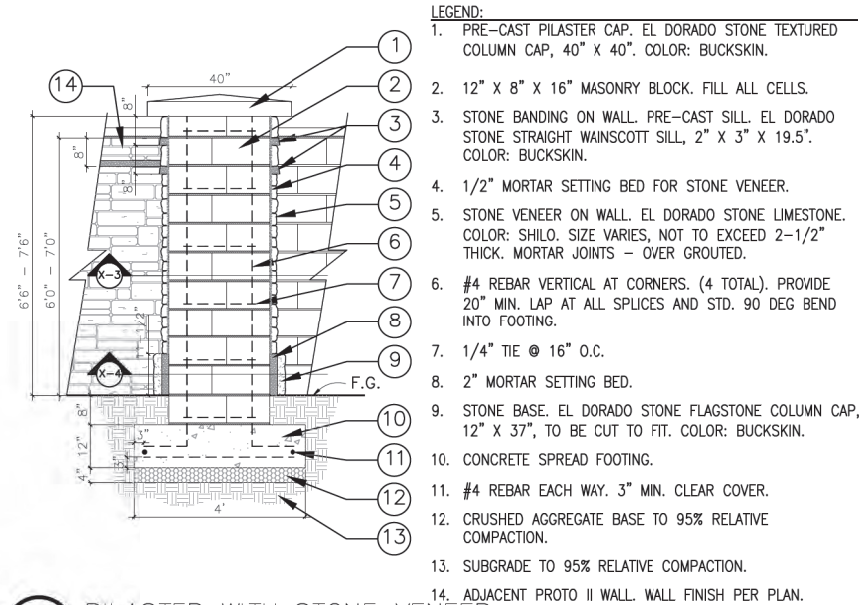

A PILASTER WITH STONE VENEER
SCALE: 1/2" = 1' - 0"

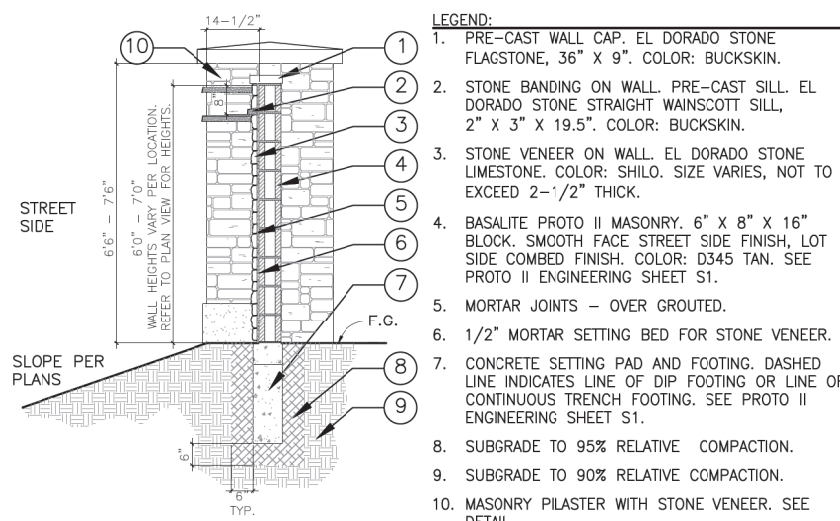

B PROTO II WALL WITH STONE VENEER
SCALE: 1/2" = 1' - 0"

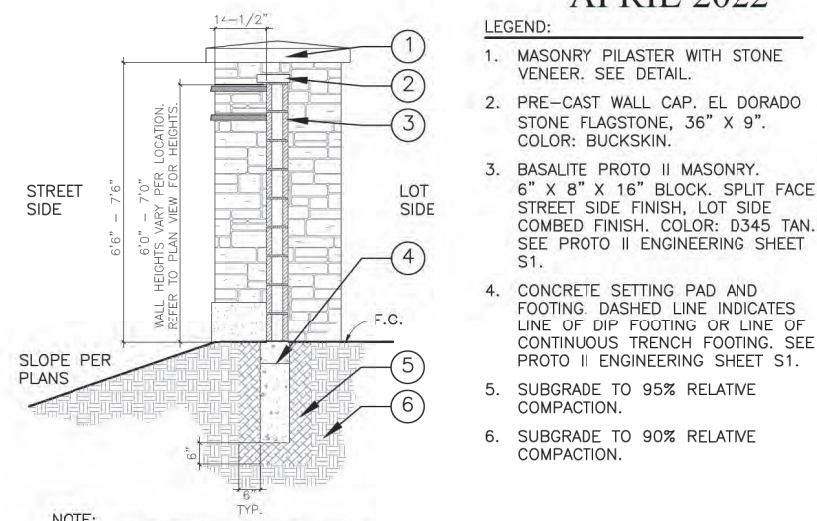

C PROTO II WALL
SCALE: 1/2" = 1' - 0"

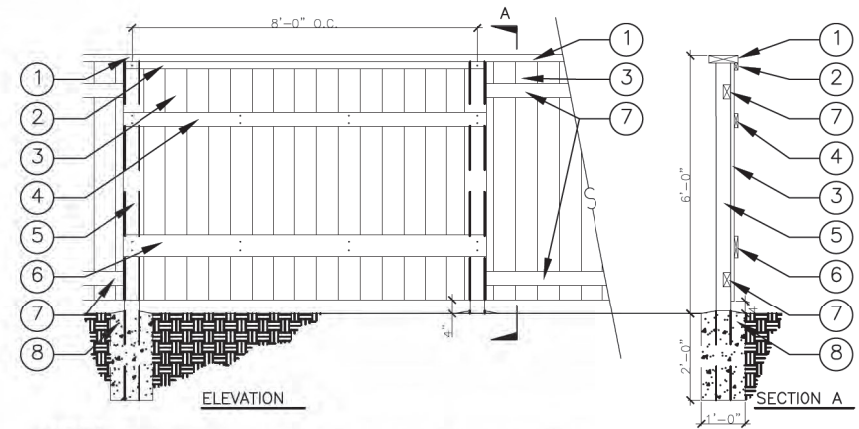

D WOOD FENCE - GOOD NEIGHBOR
SCALE: 1/2" = 1' - 0"

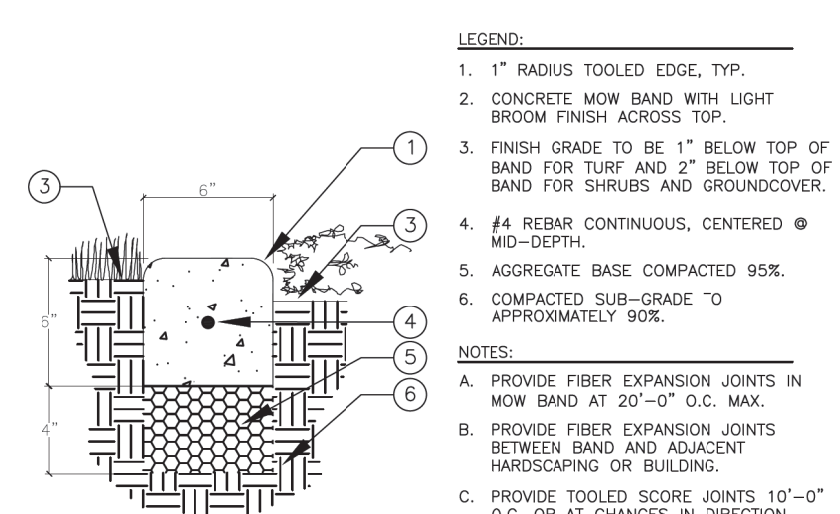

E 6" CONCRETE MOW BAND
SCALE: 3" = 1' - 0"

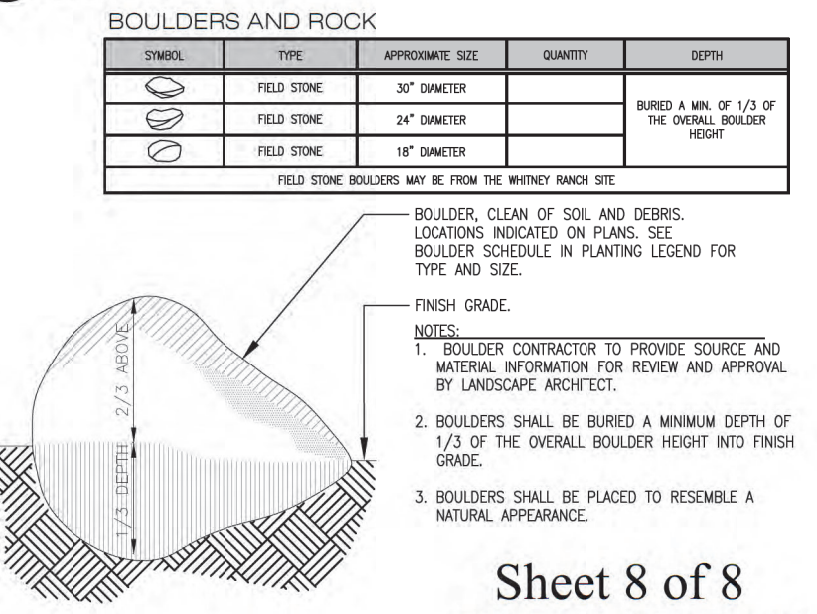

F BOULDER PLACEMENT
SCALE: 1/2" = 1' - 0"

Sheet 8 of 8 PRELIMINARY PLANTING DETAILS

**FUHRMAN LEAMY
LAND GROUP**
DESIGN • SERVICE • SOLUTIONS
2140 PROFESSIONAL DRIVE, SUITE 115 ROSEVILLE, CA 95661
(916) 783-5263 info@fllandgroup.com

UBORA ENGINEERING & PLANNING
"EXCELLENCE"
2901 DOUGLAS BOULEVARD, SUITE 285
ROSEVILLE, CA 95661 (916) 780-2500

WHITNEY RANCH UNIT 49 PARK CONNECTIVITY EXHIBIT

OCTOBER 14, 2022



NOTE: CITY IS CURRENTLY STUDYING THE POTENTIAL FOR ADDING STOP SIGNS & CROSSWALKS AT THE BARONIAL/OLD RANCH HOUSE ROAD INTERSECTION

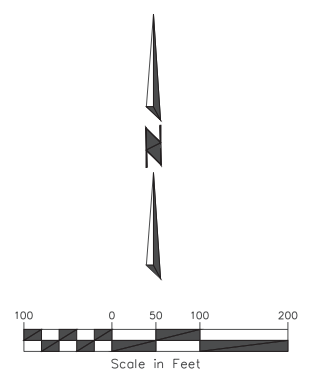
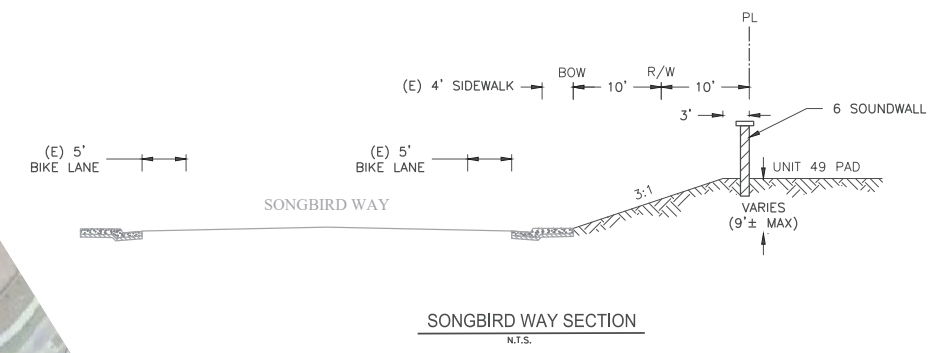

UBORA ENGINEERING & PLANNING
"EXCELLENCE"
2901 DOUGLAS BOULEVARD, SUITE 285
ROSEVILLE, CA 95661 (916) 780-2500

P:\projects\11010 Whitney Ranch\Unit 49\CAD\Extras\Trail Connectivity Exhibit.dwg